

INSTALLATION AND MAINTENANCE INSTRUCTIONS

SpectrAlert Selectable Output Strobes, Horns, and Horn/Strobes

For use with the following models:

Strobes - 12/24 volt: S1224MC, S1224MCW, S1224MCSP, S1224MCSPW, S1224MCP, S1224MCPW

Combo - 12/24 volt: P1224MC, P1224MCW, P1224MCSP, P1224MCSPW, P1224MCP, P1224MCPW

Horns - H12/24, H12/24W

Suffix "W" indicates white housing models. Suffix "SP" indicates "FUEGO" (Spanish word for "FIRE") lettering on housing. Suffix "P" indicates plain housing (no lettering).

The Products to which this manual applies may be covered by one or more of the following U.S. Patent numbers: 5,914,665; 5,850,178; 5,598,139; 6,049,446; 5,593,569, 6,133,843; 6,522,261



3825 Ohio Avenue, St. Charles, Illinois 60174
1-800-SENSOR2, FAX: 630-377-6495
www.systemsensor.com

SPECTRAlert®

Specifications

Automatic selection for 12 or 24 volt rated operation (DC or Full-Wave Rectified)

Electrical

For Horns, Strobes, and Horn/Strobes

Voltages: Regulated 12 DC/FWR and Regulated 24 DC/FWR

Operational Voltage Ranges: 8-17.5 Volts and 16-33 Volts

Synchronous Applications

with MDL Module: 9-17.5 Volts and 17-33 Volts

NOTE: Horn units will operate on walk tests with on-time durations of .25 sec. or greater.

Flash Rate: 1 flash per second

Operating Temperature: 32° F to 120° F (0° C to 49° C)

Selectable Light Outputs: All candelas are selectable via a manual slide switch.

12/24 Volt Applications: 15 or 15/75 candela

24 Volt Application: 30, 75, 110 candela

15/75 is listed at 15 candela per UL 1971 but will provide 75 candela on axis (straight ahead). 15, 30, 75, or 110 are rated for that candela.

Sound Output: Sound output levels are established at Underwriters Laboratories in their reverberant room. Always use the sound output specified as UL Reverberant Room when comparing products.

Listings: UL S5512 (Strobe); UL S4011 (Combo)

Note for Strobes: Do not exceed: 1) 8-17.5 or 16-33 voltage range limit; 2) maximum number of 70 strobe lights when connecting the MDL Sync module with a maximum line impedance of 4 ohms per loop and; 3) maximum line impedance as required by the fire alarm control manufacturer.

The models S1224MC, S1224MCW, S1224MCSP, S1224MCSPW, S1224MCP, S1224MCPW, P1224MC, P1224MCW, P1224MCSP, P1224MCSPW, P1224MCP, and P1224MCPW incorporate a new patent-pending voltage booster design that has a more consistent flash bulb voltage over the range of candela selections. The benefit to the customer is a high quality strobe device.

General Description

The SpectrAlert series notification appliances are designed to meet the requirements of most agencies governing these devices, including: NFPA, ADA, The National Fire Alarm Code, UL, ULC, FM, CSFM, MEA. Also, check with your local Authority Having Jurisdiction for other codes or standards that may apply.

The SpectrAlert series can be installed in systems using 12- or 24-volt panels having DC or full-wave rectified (FWR) power supplies. The series can also be installed in systems requiring synchronization (module MDL or compatible equivalent required) or systems that do not require synchronization (no module required).

NOTICE: This manual shall be left with the owner/user of this equipment.

Fire Alarm System Considerations

Temporal and Non-Temporal Coded Signals:

The American National Standards Institute and the National Fire Alarm Code require that all horns used for building evacuation installed after July 1, 1996, must produce Temporal Coded Signals.

Signals other than those used for evacuation purposes do not have to produce the Temporal Coded Signal. Temporal coding is accomplished by interrupting a steady sound in the following manner:

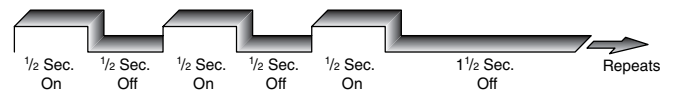

Power Supply Considerations

Panels typically supply DC filtered voltage or FWR (full-wave rectified) voltage. The system design engineer must calculate the number of units used in a zone based on the type of panel supply. Be certain the sum of all the device currents do not exceed the current capability of the panel. Calculations are based on using the device current found in the subsequent charts and must be the current specified for the type of panel power supply used.

Wire Sizes

The designer must be sure that the last device on the circuit has sufficient voltage to operate the device within its rated voltage. When calculating the voltage available to the last device, it is necessary to consider the voltage drop due to the resistance of the wire. The thicker the wire, the less the voltage drop. Generally, for purposes of determining the wire size necessary for the system, it is best to consider all of the devices as “lumped” on the end of the supply circuit (simulates “worst case”).

Typical wire size resistance:

- 18 AWG solid: Approximately 8 ohms/1,000 ft.
- 16 AWG solid: Approximately 5 ohms/1,000 ft.
- 14 AWG solid: Approximately 3 ohms/1,000 ft.
- 12 AWG solid: Approximately 2 ohms/1,000 ft.

Example: Assume you have 10 devices on a zone and each requires 50 mA average and 2000 Ft. of 14 AWG wiring (total length = outgoing + return). The voltage at the end of the loop is 0.050 amps per device x 10 devices x 3 ohms/1,000 ft. x 2000 ft = 3 volts drop.

Note: If class “A” wiring is installed, the wire length may be up to 4 times the single wire length in this calculation.

The same number of devices using 12 AWG wire will produce only 2 volts drop. The same devices using 18 AWG wire will produce 8 volts drop. Consult your panel manufacturer’s specifications, as well as SpectrAlert’s operating voltage range to determine acceptable voltage drop.

Figure 1A: Current Draw Measurements

NOTE: All ‘S’ and ‘P’ models were only tested at the 8-17.5 and 16-33 Volt-FWR/DC limits. This does not include the 80% low-end or 110% high-end voltage limits.

Model No.	Candela Setting	FWR Operating Current–Strobe (mA RMS)		DC Operating Current–Strobe (mA RMS)		FWR Operating Current–Horn (mA RMS)		DC Operating Current–Horn (mA RMS)		Horn Audibility (dBA)
		12V	24V	12V	24V	12V	24V	12V	24V	
S1224MC Strobe	15	112	64	127	59					
	15/75	135	74	127	69					
	30		93		90					
	75		158		160					
	110		208		209					
P1224MC Horn/Strobe	15	112	64	127	59	45.7	57.5	44.4	57	75
	15/75	135	74	127	69	45.7	57.5	44.4	57	75
	30		93		90		57.5		57	75
	75		158		160		57.5		57	75
	110		208		209		57.5		57	75
H12/24 Horn						45.7	57.5	44.4	57	75

Figure 1B: Selectable Horn Tones

Temporal	Low Volume	Electromechanical 3000 Hz Interrupted
	High Volume	Electromechanical 3000 Hz Interrupted
Non-Temporal	Low Volume	Electromechanical 3000 Hz Interrupted
	High Volume	Electromechanical 3000 Hz Interrupted

Figure 2: Candela Selections

For strobe candela selection, adjust slide switch located on the rear of the product while watching the viewing window on the side of the reflector.

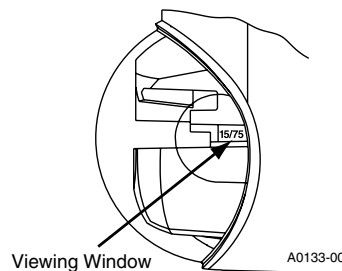

Permissible Candela Settings:

Candela Setting	Operating Voltage	
	12V	24V
15	OK	OK
15/75	OK	OK
30		OK
75		OK
110		OK

NOTE: SpectrAlert selectable output strobes, set at 15 and 15/75cd, automatically work on both 12V and 24V power supplies.

NOTE: The strobe is not listed for 12V operating voltages when set to 30, 75 or 110 candelas. Use only those settings marked as OK in the chart above.

⚠ WARNING

When using a 12V panel, this device will yield required light output only in the 15 or 15/75 candela setting.

Figure 3: Horn Factory Default Setting

The factory default setting is High, Temporal 3, and Electromechanical tone.

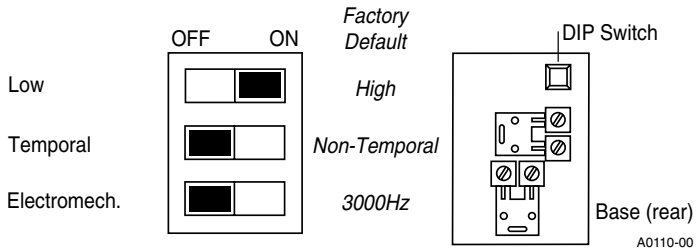

Horn selections using 3-position DIP switch on horn/strobe (refer to Figure 3):

Note: When powered from a FWR supply, the horn will be modulated (turned on and off) by 120Hz causing it to sound different than if powered by a DC supply.

High/Low Volume

ON = High Volume, OFF = Low Volume

Note: The low volume setting of some tones must NOT be used for public mode applications when the device

is powered from a 12-volt panel. Refer to the Sound Output Guide on the previous page.

Temp/Non-Temp

ON = NON-Temporal, OFF = Temporal

3KHz/Electromechanical

ON = 3KHz, OFF = Electromechanical

Tone pattern override options using compatible panels:

The Selectable Output Horn/Strobe may be commanded to override the horn selection. Horns and strobes may be overridden to the patterns listed below:

1. Continuous EM
2. Temporal EM
3. Double March Time EM (240 strokes/min.)
4. March Time EM (120 strokes/min.)
5. Canadian EM (20 strokes/min.)
6. Strobe Disable
7. Strobe Enable

For complete details, refer to panel Installation Manual.

⚠ WARNING Check terminal polarity before wiring. For proper operation, make sure the correct wire polarity is applied to the unit.

System Operation – Non-Synchronized Devices:

Figure 4a: Any combination of models powered by a 2-wire circuit:

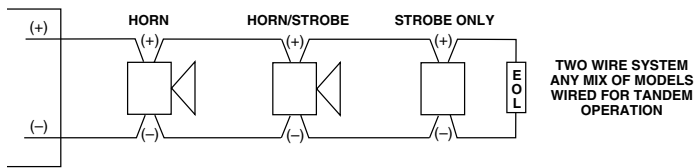

System Operation – Synchronized Devices:

Figure 4b: Any combination of models powered by a 2-wire circuit:

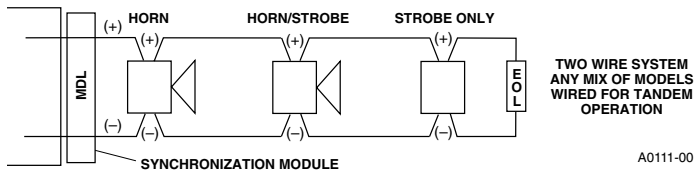

Figure 5: Horns and strobes powered in tandem

NOTE: Supply power must be continuous for proper operation.

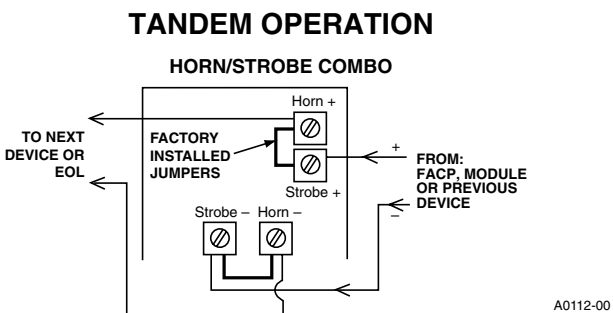

Figure 6: Any combination of models powered by a 4-wire circuit to provide independent horn and strobe operation (remove factory installed jumpers, see Figure 8)

NOTE: Strobes must be powered continuously for horn operation.

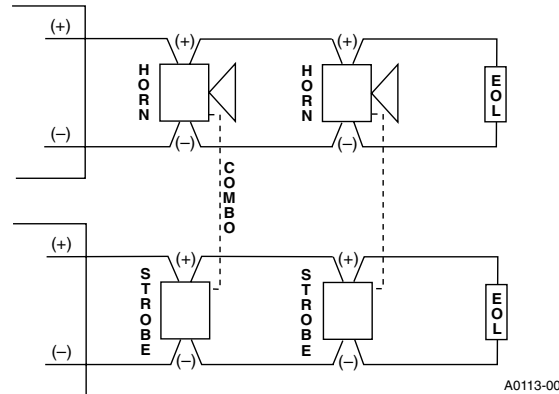

Figure 7: Horns and strobes powered independently (horn operated on coded power supply)

NOTE: Strobes must be powered continuously for horn operation.

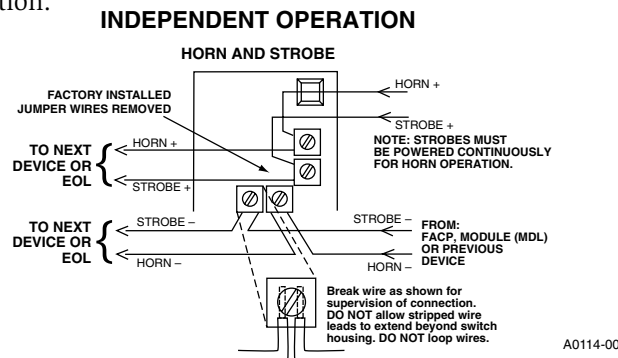
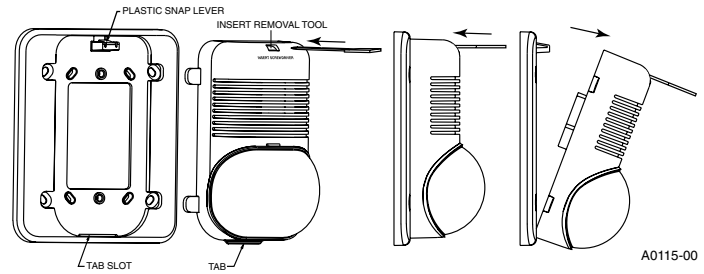

Figure 8: Removal of horns and strobes from mounting plates

To remove units from mounting plates, insert Quick Click Removal Tool as shown to unlock snap. While pushing in Removal Tool to release the snap, pull back on the horn/strobe. Hinge the horn/strobe module, disengage the Locking Rib, and lift the horn/strobe away from the mounting plate.



Mounting Diagrams:

Screw types used for mounting:

- A = 8-32 x 3/4 flat head
- B = 6-32 x 1 1/16 pan head

Strobe or Horn/Strobe with universal mounting plate:

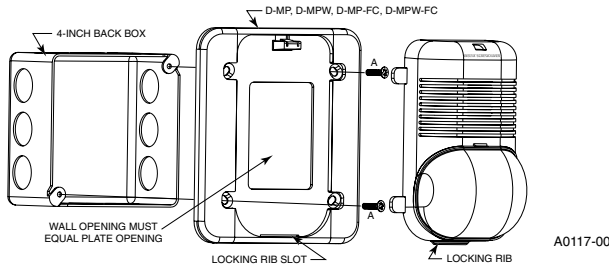

1. Mount plate to back box using screws A, making sure wall opening is equal to the plate opening.
2. Complete field wiring.
3. Insert locking rib into slot on plate.
4. Press into plate, unit will make a “click” when it has locked into place.

Strobe or Horn/Strobe with small footprint mounting plate:

1. Mount plate to back box using screws B.
2. Break off four tabs from unit.
3. Complete field wiring, making sure wall opening is large enough for terminals to fit through.
4. Insert locking rib into slot on plate.
5. Press into plate; unit will make a “click” when it has locked into place.

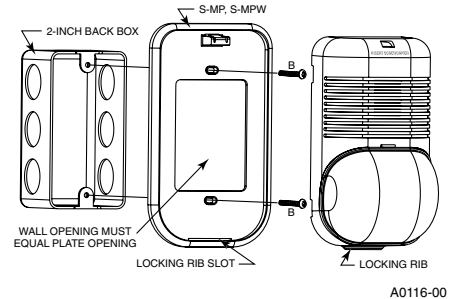

Strobe or Horn/Strobe surface mount:

1. Mount skirt to back box with screws A.
2. Complete field wiring.
3. Insert locking rib on unit into slot on skirt.
4. Press into skirt; unit will make a “click” when it has locked into place. (Note: Strobe and skirt may also be mounted to a 2-inch box using screws B instead of screws A.)

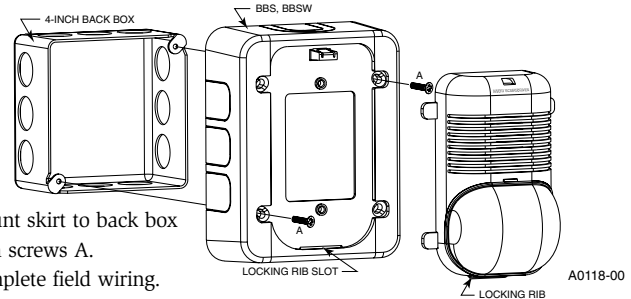

Please refer to insert for the Limitations of Fire Alarm Systems



The Limitations of Horn/Strobes

The horn and/or strobe will not work without power. The horn/strobe gets its power from the fire/security panel monitoring the alarm system. If power is cut off for any reason, the horn/strobe will not provide the desired audio or visual warning.

The horn may not be heard. The loudness of the horn meets (or exceeds) current Underwriters Laboratories' standards. However, the horn may not alert a sound sleeper or one who has recently used drugs or has been drinking alcoholic beverages. The horn may not be heard if it is placed on a different floor from the person in hazard or if placed too far away to be heard over the ambient noise such as traffic, air conditioners, machinery or music appliances that may prevent alert persons from hearing the alarm. The horn may not be heard by persons who are hearing impaired.

NOTE: Strobes must be powered continuously for horn operation.

The signal strobe may not be seen. The electronic visual warning signal uses an extremely reliable xenon flash tube. It flashes at least once every second. The strobe must not be installed in direct sunlight or areas of high light intensity (over 60 foot candles) where the visual flash might be disregarded or not seen. The strobe may not be seen by the visually impaired.

The signal strobe may cause seizures. Individuals who have positive photic response to visual stimuli with seizures, such as persons with epilepsy, should avoid prolonged exposure to environments in which strobe signals, including this strobe, are activated.

The signal strobe cannot operate from coded power supplies. Coded power supplies produce interrupted power. The strobe must have an uninterrupted source of power in order to operate correctly. System Sensor recommends that the horn and signal strobe always be used in combination so that the risks from any of the above limitations are minimized.

Three-Year Limited Warranty

System Sensor warrants its enclosed horn, strobe, or horn/strobe to be free from defects in materials and workmanship under normal use and service for a period of three years from date of manufacture. System Sensor makes no other express warranty for this horn, strobe, or horn/strobe. No agent, representative, dealer, or employee of the Company has the authority to increase or alter the obligations or limitations of this Warranty. The Company's obligation of this Warranty shall be limited to the repair or replacement of any part of the horn, strobe, or horn/strobe which is found to be defective in materials or workmanship under normal use and service during the three year period commencing with the date of manufacture. After phoning System Sensor's toll free number 800-SENSOR2 (736-7672) for a Return Authorization number, send defective units postage prepaid

to: System Sensor, Returns Department, RA # _____, 3825 Ohio Avenue, St. Charles, IL 60174. Please include a note describing the malfunction and suspected cause of failure. The Company shall not be obligated to repair or replace units which are found to be defective because of damage, unreasonable use, modifications, or alterations occurring after the date of manufacture. In no case shall the Company be liable for any consequential or incidental damages for breach of this or any other Warranty, expressed or implied whatsoever, even if the loss or damage is caused by the Company's negligence or fault. Some states do not allow the exclusion or limitation of incidental or consequential damages, so the above limitation or exclusion may not apply to you. This Warranty gives you specific legal rights, and you may also have other rights which vary from state to state.

FCC Statement

SpectrAlert Strobes and Horn/Strobes have been tested and found to comply with the limits for a Class B digital device, pursuant to part 15 of the FCC Rules. These limits are designed to provide reasonable protection against harmful interference when the equipment is operated in a commercial environment. This equipment generates, uses, and can radiate radio frequency energy

and, if not installed and used in accordance with the instruction manual, may cause harmful interference to radio communications. Operation of this equipment in a residential area is likely to cause harmful interference in which case the user will be required to correct the interference at his own expense.